



Tel: 0845 467 2378
Tel: +44 (0)1236 756900 (UK)
Email: sales@bestpump.co.uk
www.bestpump.co.uk

..... SERVING FOOD PROCESSORS SINCE 1946

WHAT MAGTRAPS DO

.....

MAGTRAPs remove the hazards of unwanted ferrous and work-hardened stainless contaminants from processing lines. They capture the very fine of particles that pass undetected through electronic metal detectors. Placed in front of pumps, screens and mills, they protect vital plant equipment from metal damage, with its costly resultant - downtime. When product purity is paramount, install a MAGTRAP in front of the filler. MAGTRAPs work with virtually all pumped products. Their rare earth magnets catch all sizes of ferrous debris found in product lines. They also capture particles of work-hardened 304 and 316 stainless steels as well as nickel and carbide items that sometimes appear in process lines. MAGTRAPs are available from 1/2" through 6" line sizes.

TWO MAGTRAP STYLES

.....

MAGTRAPs magnets are either enclosed in tubes (Models 130, 135, 135EC, 170 and Micro Magtrap) or in a flat plate configurations (Models 115, 120 and 125). Tube magnets are used for liquids, purees, and products with smaller (less than 1/2") included solids not susceptible to size reduction. Flat plate magnets are for products with fragile included solids (fruit preserves, cooked meat chunks, cottage cheese, etc.), chunks larger than 1/2", long, sinewy items, and products that are hard to pump.

USEFUL NOTES

.....

MAGTRAPs can be supplied with all types of line connectors. Models 125 and 135 can have dissimilar inlet and outlet line sizes. MAGTRAPs may be mounted in vertical, horizontal or sloped lines without affecting the magnetic efficiency. For complete drainage required by Clean-In-Place (CIP) systems (no sump area), install MAGTRAPs in a vertical line. CESCO would be pleased to provide you with suggestions and information regarding your application. Complete instructions accompany every MAGTRAP.

GOOD REASONS FOR USING CESCO MAGTRAPS

-
- No Electricity
 - No Moving Parts
 - Built to Sanitary Standards
 - Easy to Install
 - Available to 300°F
 - Built to Last
 - Pressures to 200 psi
 - Easy to Clean
 - Clean-In-Place (CIP) Capable
 - Captures Items Smaller than Electronic Metal Detectors Sense

MAGTRAPS

• MODEL 135 •



• All 316 Stainless Steel • Rare Earth Magnets Available To 300°F • All US Components



SANITARY INTERIOR
CNC WELDS

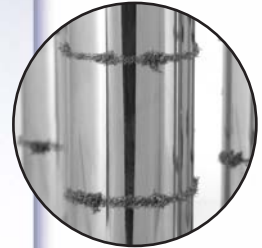

TRAPPED METAL



MAGTRAP IN-LINE



MAGTRAP MODEL 135

Our most popular and effective MAGTRAP has USDA approval (*US Department of Agriculture Approved*). Designed for liquids and slurries with chunks up to 1/2". In the exploded view, the product flows from right-to-left through intense, multiple, magnetic fields generated by the protruding tubes. Trash is held on the tubes, until the unit is cleaned. Units to 2" line size have five tubes, while 2 1/2" to 4" line sizes have seven tubes. The removable base makes the unit easily accessible for cleaning. Water jackets are optional.

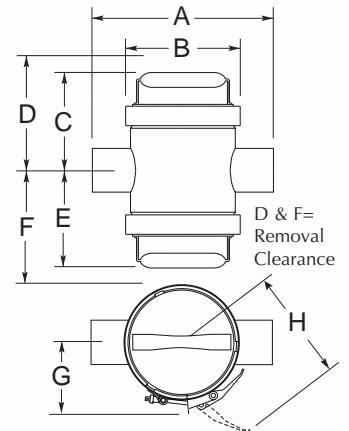

Magtrap Dimensions & Weights (Inches & Pounds)

Line Size	A	B	C	D	E	F	G	H	Net Wt.	Ship Wt.
1.5"-2"	8.25*	7	4.4	8.5	4.4	4.9	5.3	8.7	23.4	28
2.5"-3"	10.25*	9	5.1	10.3	5.1	5.6	6	10	38.5	48
4"	10.25*	9	5.9	12.5	5.9	6.4	6	10	49.7	59

*Standard line connections only - Others may vary



C E S C O

• MODEL 125 •



• All 316 Stainless Steel • Rare Earth Magnets Available To 300°F • All US Components

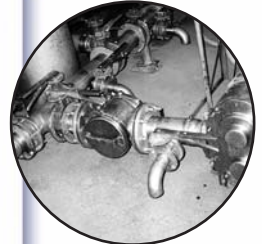

MAGTRAP IN-LINE

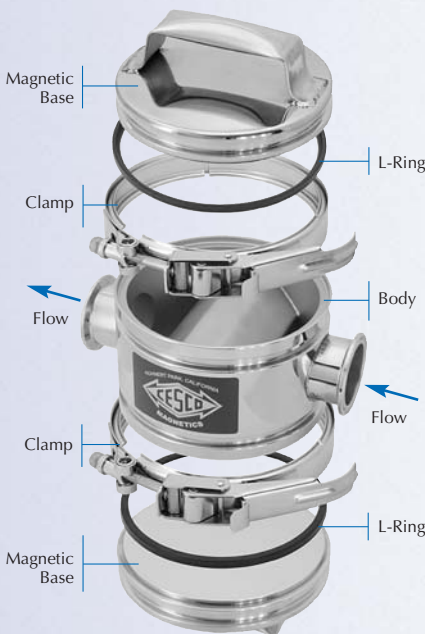

MAGTRAP MODEL 125

These USDA approved (*US Department of Agriculture Approved*) units are for high volume applications requiring gentle flow characteristics. From the exploded view, the product flow is split by the internal baffle and diverted onto two flat plate magnets. Line sizes to 4". Water jackets are optional.

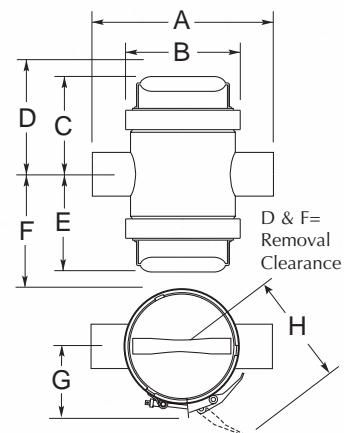

Magtrap Dimensions & Weights (Inches & Pounds)

Line Size	A	B	C	D	E	F	G	H	Net Wt.	Ship Wt.
1.5"-2"	8.25*	7	4.8	5.3	4.8	5.3	5.3	8.7	27.8	33
2.5"-3"	10.25*	9	5.7	6.2	5.7	6.2	6	10	45.7	55
4"	10.25*	9	6.5	7	6.5	7	6	10	55	64

*Standard line connections only - Others may vary

Join the Food Processors
Who's Who List

Specify CESCO
Magnetic Separator



MAGTRAPS

• MODEL 115 •



• All 316 Stainless Steel • Rare Earth Magnets Available To 300°F • All US Components

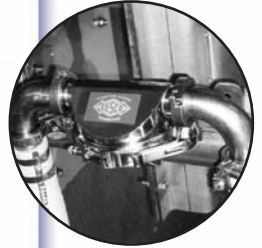

MAGTRAP IN-LINE



MAGTRAP MODEL 115

These USDA approved (*US Department of Agriculture Approved*) units are for low volume applications requiring gentle flow characteristics. It provides minimum tearing and breakage of fragile solids. In the exploded view, product can flow in either direction, past the flat plate magnet. Currently available in 2" and 3" line sizes.

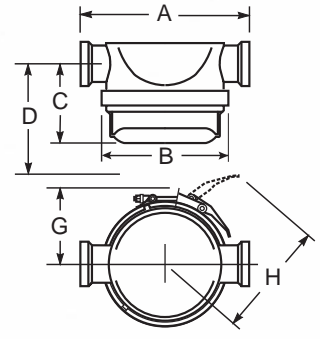

D & F= Removal Clearance

Magtrap Dimensions & Weights (Inches & Pounds)

Line Size	A	B	C	D	E	F	G	H	Net Wt.	Ship Wt.
2"	8.25*	7	4.9	5.4	-	-	5.3	8.7	24	29
3"	10.25*	9	5.6	6.1	-	-	6	10	43	53

*Standard line connections only - Others may vary

CESCO builds
QUALITY equipment made
to your satisfaction.

CESCO for all your
magnetic separator needs.





..... SERVING FOOD PROCESSORS SINCE 1946

HOW TO SIZE A MAGTRAP

Maximum magnetic efficiency is attained with slow flow rates. It is easier to extract metal through low viscosity products than through high viscosity products. With the above in mind, use **TABLE A** to select your product's viscosity class (Example: Water is Class 1, Molasses = Class 4), then move to **TABLE B**. From Table B, match your line's viscosity class and maximum pumping capacity with the various MAGTRAP model's maximum flow ratings, then select the appropriate model and line size. Line reducers (expanders) may be needed. When operating at or near a MAGTRAP's upper flow capacity, move up one line size to assure meeting future increased pumping needs.

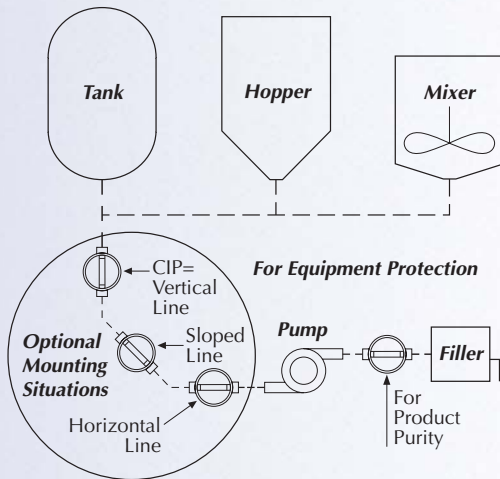

TABLE A

Select a class that best matches the most viscous product to be pumped. Remember that temperature and percent of liquid can greatly affect a product's viscosity class. If needed, water jackets can be added to heat or cool the product.

CLASS 1

Beverages, clear broths, thin soups, juices, warm jellies, light sauces, thin salad dressings.

CLASS 2

Applesauce, pulped fruits and vegetables, syrups, custards, baby foods, cranberries, hot preserves.

CLASS 3

Chopped foods, creamed cheese, pumpkin filling, frozen slush, heavy sauces, batters, heavy purees.

CLASS 4

Cooled products, pet foods, nut butters, minced meat, thick batters and slow flowing products.

TABLE B - MODEL 135

Line Size	Maximum Flow - Gallons/Minute				Maximum Pressure
	Class 1	Class 2	Class 3	Class 4	
1.5"-2"	150	105	60	30	200 PSI
2.5"-3"	250	175	100	50	200 PSI
4"	340	240	140	70	200 PSI

TABLE B - MODEL 125

Line Size	Maximum Flow - Gallons/Minute				Maximum Pressure
	Class 1	Class 2	Class 3	Class 4	
1.5"-2"	130	90	52	26	200 PSI
2.5"-3"	200	140	80	40	200 PSI
4"	250	175	100	50	200 PSI

TABLE B - MODEL 115

Line Size	Maximum Flow - Gallons/Minute				Maximum Pressure
	Class 1	Class 2	Class 3	Class 4	
2"	60	42	24	12	200 PSI
3"	85	60	34	17	200 PSI

FOOD GRADE L-RING GASKETS

PROPERTY	EPDM (Std.)	BUNA-N	VITON
Temperature Range	-50 to 400°F.	-20 to 225°F.	-15 to 400°F.
Acid resistance	fair	good	excellent
Alkali resistance	good	fair	good
Veg. Oil resistance	poor	excellent	excellent
Steam, to 350°F	good	poor	poor

LINE CONNECTIONS (FERRULES)

Tri-Clamp and weld ends are standard. To assure a perfect weld end match, specify your line's outside and inside diameters. Bevel Seat (Acme Thread), International Dairy Fitting (IDF), pipe sizes and threads, Victaulic, Cam-Lock, John Perry, I-line, Q-line, 150# pipe flanges, connections with captive nuts and various other domestic and European sanitary ferrules are available. Non-similar end sizes are available on Models 125 and 135. Inquire regarding other connection options.

OTHER CESCO MAGTRAPS

CESCO Model 170 MAGTRAPS for pressures to 800 psi, Micro MAGTRAPS for micro line size applications, Models 120's and 130's for 6" line size and Model 135EC's (Easy Clean) that allow easy removal of captured trash and pneumatic actuation.

Continual improvement and customization require that these specifications are subject to change without notice.